

1. PRODUCT OVERVIEW

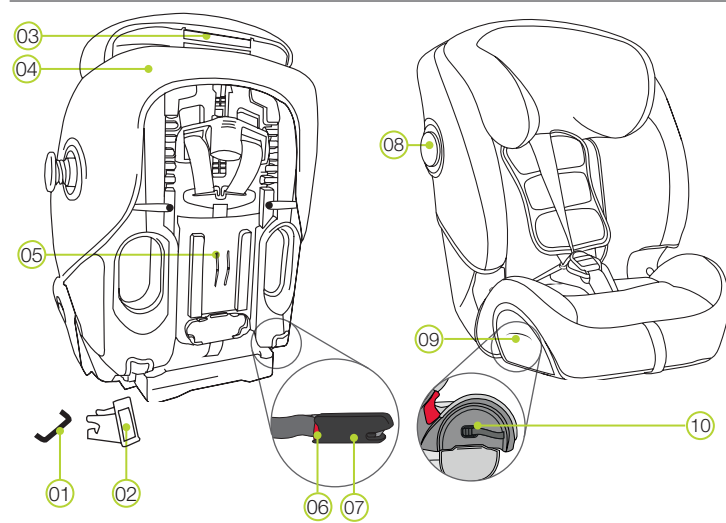

- 01 ISOFIX fastening points (car)
- 02 ISOFIX insertion aids
- 03 Headrest adjuster
- 04 Backrest
- 05 Compartment for the user instructions
- 06 ISOFIT Locking button
- 07 ISOFIT locking arms
- 08 SICT
- 09 Cover flap
- 10 ISOFIT adjustment button

If you have any questions regarding the use of the product, please feel free to contact us:
BRITAX RÖMER Kindersicherheit GmbH
 Blaubeurer Strasse 71
 D-89077 Ulm
 Germany
 T.: +49 (0) 731 9345-199/-299
 F.: +49 (0) 731 9345-210
 E.: service.de@britax.com
 www.britax.eu

BRITAX EXCELSIOR LIMITED
 1 Churchill Way West
 Andover
 Hampshire SP10 3UW
 United Kingdom
 T.: +44 (0) 1264 333343
 F.: +44 (0) 1264 334146
 E.: service.uk@britax.com
 www.britax.eu

5. CHANGING THE HARNESS

- Removing the 5-point harness**
- Loosen the harness straps as far as possible (see 9.1).
 - Push the shoulder strap adjuster (24) all the way up (see 8.1).
 - Unhook the shoulder straps (13) from the connecting piece (14).
 - Clip the connecting piece (14) at the bottom of the backrest (04) into its holder (11).
 - Push down the strap loops of the shoulder pads (18) from the base of the shoulder strap adjuster (24).
 - Pull the shoulder straps (13) and the strap loops of the shoulder pads (18) out of the belt slots.
 - Undo the Velcro fastener on the crotch cushion (21) and remove it.
 - On the bottom of the seat, unhook the adjusting strap (23) from the metal plate (27).
 - Turn the metal plate (27) (that holds the harness buckle (19) to the seat shell) on end and push it upwards through the belt slot (28).
 - Release the harness buckle (19).
 - Push the straps and buckle tongues (30) through the lap belt slots in the cover.
 - Place the harness buckle (19) under the cover and inside the storage compartment (31) of the backrest (04).
 - Push the adjusting strap (23) under the cover.
 - Fix the shoulder pads (18) and shoulder straps (13) in the rubber loops (32) at the feed-through points (15).
- Installing the 5-point harness**
- To install the straps, follow the steps in reverse order.
 - DANGER!** Tug on the shoulder straps firmly (13) to make sure that the 5-point harness is secure.

DANGER! Never use installation method A for the child safety seat unless the harness buckle and shoulder pads are properly attached (the straight edges of the shoulder pads must be pointing towards each other). Make sure that the metal plate of the harness buckle is correctly attached.
WARNING! Ensure that the straps are not twisted, that they have not been accidentally interchanged and that they have been correctly inserted in the belt slots on the cover.

2. APPROVAL

BRITAX RÖMER Vehicle child safety seat	Tested and approved according to ECE* R 44/04 *ECE = European Standard for Child Safety Equipment	
	Group	Body weight
EVOLVA 1-2-3 SL	I	9 to 18 kg
SICT	II+III	15 to 36 kg

The child safety seat has been designed, tested and approved according to the requirements of the European Standard for Child Safety Equipment (ECE R 44/04). The seal of approval E (in a circle) and the approval number are located on the orange approval label (sticker on the child safety seat).

- DANGER!** This approval will be invalidated if you make any modifications to the child safety seat. Only the manufacturer is permitted to make modifications to the child safety seat.
- WARNING!** Use the EVOLVA 1-2-3 SL SICT exclusively for securing your child in your vehicle. It is in no way suitable for use as a seat or toy in the home.
- DANGER!** Never secure your child or the child safety seat with a 2-point belt. If you secure your child in the child seat with only a 2-point belt, this may cause serious injuries to your child in the event of an accident and could even result in their death.



3. SAFETY NOTES

Please take the time to read these instructions carefully and keep them to hand in the intended storage compartment (05) on the child safety seat at all times! The instructions must be kept with the child safety seat if the latter is passed on to a third party.

- DANGER!** For the protection of your child:
 In the event of an accident at a collision speed of more than 10 km/h, the child safety seat may be damaged without the damage becoming immediately visible. In this case, the child safety seat must be replaced. Please dispose of it properly.
- Always have your child safety seat checked if you suspect it may have been damaged (e.g. if it falls on the ground).
 - Regularly check all important parts for damage. Ensure that all mechanical parts, in particular, are fully functional.
 - Never lubricate or oil parts of the child seat.
 - Never leave your child unattended in the child seat in the vehicle.
 - Only allow your child to enter and exit the vehicle on the pavement side.
 - Protect the child safety seat from intensive direct sunlight when it is not in use. The child safety seat can get very hot in direct sunshine. Children's skin is sensitive and could be harmed as a result.
 - The more snugly the belt fits over your child's body, the better they will be protected. Avoid putting thick clothes on your child under the belt.
 - Take regular breaks on long journeys in order to give your child the opportunity to run about and play.
 - Use on the rear seat: Move the front seat far enough forwards to ensure that your child's feet cannot hit the backrest of the front seat (to prevent risk of injury).
 - If your child tries to open the red ISOFIT safety button (06) or a buckle, stop the vehicle as soon as it is safe to do so. Check whether the child safety seat is correctly fastened and ensure that your child is correctly secured. Explain to your child the dangers associated with their actions.
- DANGER!** For the protection of all vehicle occupants:
 In the case of an emergency stop or an accident, unsecured persons or objects may cause injury to other vehicle occupants. Please always check that:
- the backrests of the vehicle seats are locked, e.g. that a foldable rear seat bench latch is engaged.
 - all heavy or sharp-edged objects in the vehicle (e.g. on the parcel shelf) are secured.
 - all persons in the vehicle have their seat belts fastened.
 - the child safety seat is always secured when it is in the vehicle, even if no child is being transported.
- WARNING!** For your protection when handling the child seat:
- Never use the child safety seat free standing, not even for test sitting.
 - To avoid damage, ensure that the child safety seat is not jammed in between hard objects (car door, seat rails, etc.).
 - Keep the child safety seat in a safe place when it is not in use. Do not place any heavy objects on the seat and do not store it directly next to sources of heat or in direct sunlight.

4. USE IN THE VEHICLE

Please observe the instructions for using children's restraining systems in the operating instructions of your vehicle. The seat can be used in vehicles with ISOFIX anchoring systems (see type list) and in vehicles with a 3-point belt.
 To determine which seats are approved for use with child safety seats that meet the requirements for weight classes 9 to 18 kg and 15 to 36 kg, please refer to the operating instructions of your vehicle.

The EVOLVA 1-2-3 SL SICT is approved for two different methods of installation:

Group	Installation method	Means by which child is secured	Section of user instructions
1 (9-18 kg)	Vehicle belt	With 5-point harness	A
1 (9-18 kg)	Vehicle belt + soft latch	With 5-point harness	A
2+3 (15-36 kg)	Vehicle belt	Vehicle belt	B
2+3 (15-36 kg)	Vehicle belt + soft latch	Vehicle belt	B

^{a)} This means that the child safety seat may only be used in vehicles that are listed in the enclosed vehicle type list. This type list is consistently kept up to date. The latest version can be obtained from us or from www.britax.com

You can use your child safety seat as follows:

In the direction of travel	Yes
Against the direction of travel	No ¹⁾
With 2-point harness	No
With 3-point belt ²⁾	Yes
with ISOFIX fastening points (between seat surface and backrest)	Yes
On front passenger seat	Yes ³⁾
On outer rear seat	Yes
On centre rear seat (with 3-point belt)	Yes ⁴⁾

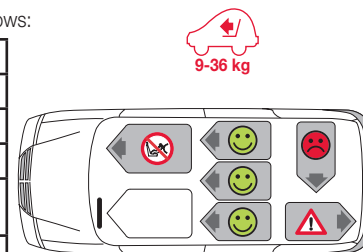

- Use on a rearward-facing vehicle seat (e.g. in a van or minibus) is only permitted if the vehicle seat is also approved for use by adults. The seat may not be in the area of effect of an airbag.
- The safety belt must be approved to ECE R 16 or a comparable standard, e.g. see whether there is an "E" or "e" in a circle on the belt test label.
- If there is a front airbag: Slide the vehicle seat a long way back and refer to any instructions in the vehicle owner's manual.
- Cannot be used if the vehicle seat is equipped with only a 2-point belt.

6. CARE AND MAINTENANCE

Please ensure that you only use original BRITAX RÖMER replacement covers, as the seat cover is an integral part of the child safety seat and fulfils important functions to ensure the smooth operation of the system. Replacement covers are available from your dealer.

- The cover can be removed and washed in accordance with the instructions on the wash care label.
 - The plastic parts can be cleaned using soapy water. Do not use any caustic cleaning agents (such as solvents).
- DANGER!** The child seat must not be used without the seat cover.
CAUTION! Never remove the buckle tongues (30) from the straps.

- Removing the cover**
- Adjust the headrest by moving it up (16) (see 9.1).
 - Unhook the edge of the cover and the rubber loops on the back of the headrest (16).
 - Pull off the cover of the headrest (16).
 - Unhook the rubber loops from the retaining screws on the backrest (04).
 - Loosen the shoulder straps (13) (see 9.2).
 - Undo the Velcro fastener on the crotch cushion (21) and remove it.
 - Open the snaps on the left and right-hand sides of the backrest cover (04).
 - Unthread the harness buckle (19) and the adjusting strap (23) from the cover.
 - On the bottom of the seat, unhook the rubber loop of the cover from the retaining screws and cover flaps (24).
 - Working from the side, carefully pull the edge of the cover on the backrest (04) over the SICT (08).
 - Slide the cover with opening over the headrest (16).
- The cover can now be washed in accordance with the instructions on the wash care label.
- Re-fitting the cover**
- Proceed in reverse order to re-fit the cover.
 - WARNING!** Ensure that the straps are not twisted and that they have been correctly inserted in the belt slots on the cover.

7. HARNESS BUCKLE CARE

To ensure the safety of your child, it is absolutely essential that the harness buckle continues to function correctly. Harness buckle malfunctions are usually caused by a build-up of soiling or by external objects.

- Possible faults:
- When you press the red release button, it takes a long time for the buckle tongues to be ejected.
 - The buckle tongues no longer engage (i.e. when you try to push them in, they pop out again).
 - The buckle tongues engage without an audible "click".
 - The buckle tongues are difficult to push in (you feel a certain amount of resistance).
- Remedy:** Clean the harness buckle so that it functions properly again:

- Cleaning the harness buckle**
- Remove the harness buckle (19) (see 5.1).
 - Soak the buckle (19) in warm water containing washing-up liquid for at least an hour.
 - Rinse the buckle (19) thoroughly and dry it.
 - Turn the metal plate (27) on end and push it downwards through the belt slot (28) in the cover and through the seat shell.
 - Turn the metal plate (27) 90° and hook the adjusting strap (23) into the metal plate (27) (5.8).
- DANGER!** Tug hard on the harness buckle (19) to make sure that it is secure.
- Push the crotch cushion (21) into the belt slot and use the Velcro fastener to fix it to the harness buckle.

DISPOSAL:
 Please observe the waste disposal regulations in your country.

Disposal of packaging	Container for cardboard boxes
Seat cover	Residual waste, waste incineration
Plastic parts	To be placed in the corresponding container according to labelling
Metal parts	Container for metals
Belt straps	Container for polyester
Buckle and tongue	Residual waste

9 to 36 kg
 (~9 months to 12 years of age)



EVOLVA 1-2-3 SL SICT

GB

User instructions

